

# Industrial thermometers

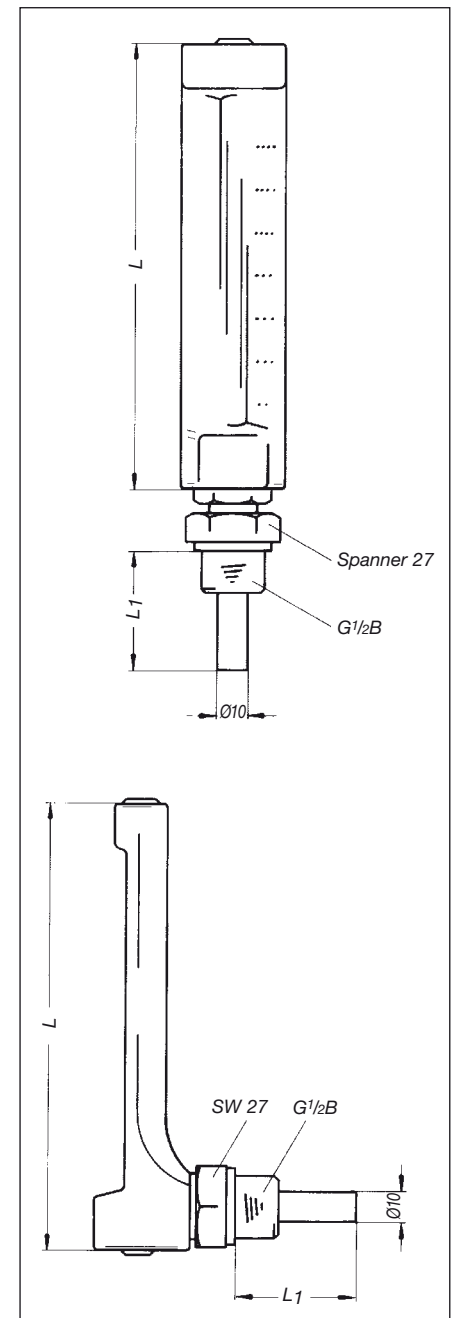

Housing types and dimensions (in mm)



## Application

Heating, industry, machine construction

## Nominal size

110 x 30 – 150 x 36 – 200 x 36

## Upper part

Aluminium, V-shaped, polished, anodised brass-coloured.

Numbers of the measuring range on the right scale side below the anodised layer, printed, black.

Adjustable by means of brass nut (spanner size 22), so that readings from any angle are possible.

## Glass insert (capillary)

Prismatic capillary – completely made from glass, Ø 6 mm.

Graduation marks of the capillary burnt in, black, completely resistant. Main graduation marks corresponding to the numbers printed in the housing are especially bold and easy-to-read.

## Thermometer filling

Standard version: blue liquid indicating from -60/+200 °C.

## Stem

Brass, Ø 10 mm, with fixed thread G<sup>1</sup>/<sub>2</sub>B.

Stainless steel version on request.

## Accuracy

DIN 16195

## Ranges °C

-30/50, 0/60, 0/120, 0/160

## Mounting position

Straight

Angled 90°

Angled 135°

## Stem lengths (mm)

40, 63, 100, 160





## Options

- Other ranges
- Other stem lengths
- Other stem materials
- Other threads
- Upper part anodised aluminium-coloured
- Upper part made from plastic
- Thermowells

Type	L	L <sub>1</sub>
VMTh 110	110	40
VMTh 150	150	63
VMTh 200	200	100
		160

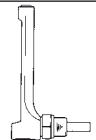
# Industrial thermometers

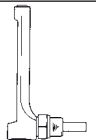
DG: H

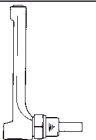
Type	VMTh 110	VMTh 110	VMTh 150	VMTh 150	VMTh 200	VMTh 200
Version						
Nominal size	110 x 30	110 x 30	150 x 36	150 x 36	200 x 36	200 x 36
DIN	16181	16182	16185	16186	16189	16190
Mounting position	Straight	Angled 90°	Straight	Angled 90°	Straight	Angled 90°
Housing	Aluminium, anodised brass-coloured					
Stem	Brass, Ø 10 mm					
Connection	Version B with screw-in socket G <sup>1</sup> / <sub>2</sub> B, brass					
Accuracy	According to DIN 16195					
Range	-30/+50 °C	-30/+50 °C	-30/+50 °C	-30/+50 °C	-30/+50 °C	-30/+50 °C
Stem length	<b>Price €</b> Part no.	<b>Price €</b> Part no.	<b>Price €</b> Part no.	<b>Price €</b> Part no.	<b>Price €</b> Part no.	<b>Price €</b> Part no.
40 mm	64101	64120	64136	64150	---	---
63 mm	64102	64121	64137	64151	64165	64181
100 mm	64103	64122	64138	64152	64166	64182
160 mm	64104	64123	64139	64153	64167	64183
Range	0/60 °C	0/60 °C	0/60 °C	0/60 °C	0/60 °C	0/60 °C
Stem length	<b>Price €</b> Part no.	<b>Price €</b> Part no.	<b>Price €</b> Part no.	<b>Price €</b> Part no.	<b>Price €</b> Part no.	<b>Price €</b> Part no.
40 mm	64106	64124	64140	64154	---	---
63 mm	64107	64125	64141	64155	64169	64185
100 mm	64108	64126	64142	64156	64170	64186
160 mm	64109	64127	64143	64157	64171	64187
Range	0/120 °C	0/120 °C	0/120 °C	0/120 °C	0/120 °C	0/120 °C
Stem length	<b>Price €</b> Part no.	<b>Price €</b> Part no.	<b>Price €</b> Part no.	<b>Price €</b> Part no.	<b>Price €</b> Part no.	<b>Price €</b> Part no.
40 mm	<b>64111</b>	<b>64128</b>	<b>64100</b>	<b>64110</b>	---	---
63 mm	64112	<b>64129</b>	<b>64105</b>	<b>64115</b>	64173	64189
100 mm	64113	<b>64130</b>	<b>64144</b>	<b>64158</b>	64174	64190
160 mm	64114	64131	64145	64159	64175	64191
Range	0/160 °C	0/160 °C	0/160 °C	0/160 °C	0/160 °C	0/160 °C
Stem length	<b>Price €</b> Part no.	<b>Price €</b> Part no.	<b>Price €</b> Part no.	<b>Price €</b> Part no.	<b>Price €</b> Part no.	<b>Price €</b> Part no.
40 mm	64116	<b>64132</b>	64146	<b>64160</b>	---	---
63 mm	64117	<b>64133</b>	64147	<b>64161</b>	64177	64193
100 mm	64118	<b>64134</b>	64148	<b>64162</b>	64178	64194
160 mm	64119	64135	64149	64163	64179	64195

Please enquire for angle 135° version.  
Additional cost for stainless steel screw-in socket €