

Capsule type pressure gauge with square bezel for panel mounting

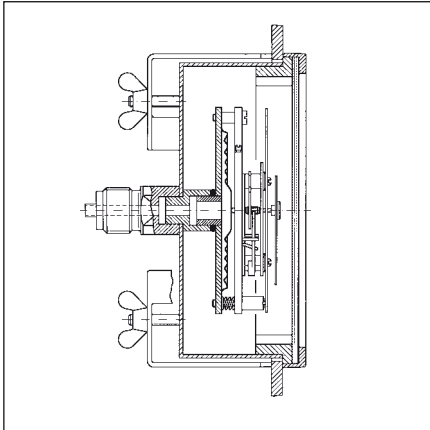

Application

For gaseous, dry media which do not attack copper alloys.
For panel mounting.

! When measuring gas or vapour, the instruments must be used in accordance with the safety recommendations of EN 837-2 (see appendix).

Typen

D 1/D 2/D 3

Nominal size

72 x 72, 96 x 96, 144 x 144

Accuracy class (EN 837-3/6)

1.6

Ranges (EN 837-3/5)

0/25 to 0/1,000 mbar and all corresponding vacuum and compound ranges with overpressure protection

Application area

Static load:
full scale value
Dynamic load:
0.9 x full scale value
Overload safety:
1.3 x full scale value

Operating temperature range

Medium: $T_{max} = +60\text{ °C}$
Ambient: $T_{min} = -20\text{ °C}$
 $T_{max} = +60\text{ °C}$

Temperature performance

Indication error when the temperature of the measuring element deviates from 20 °C:
rising temp. approx. $\pm 0.6\text{ %}/10\text{ K}$
falling temp. approx. $\pm 0.6\text{ %}/10\text{ K}$
percentage of full scale value

Protection

IP 54 (EN 60529)

Standard version

Connection

Brass, centre back
NG 72 x 72, 96 x 96 G¹/₄B –
spanner size 14
NG 144 x 144 G¹/₂B –
spanner size 22
(EN 837-3/7.3)

Measuring element

Capsule element, CuBe alloy

Movement

Brass

Zero correction

From the front

Seal

„Perbunan“ nitrile rubber

Dial

Aluminium, white
Dial marking black

Pointer

Aluminium, black

Housing

NG 72 D1 – plastic, black
NG 96 D3 – stainless steel 304
NG 144 D2 – sheet steel, black

Bezel

NG 72 plastic, black
NG 96 aluminium, black
NG 144 sheet steel, black

Front glass

Plastic

Options

- Damping screw
- Reference pointer
- Special scales

Capsule type pressure gauge with square bezel for panel mounting NG 72 x 72/96 x 96/144 x 144

Housing types and dimensions

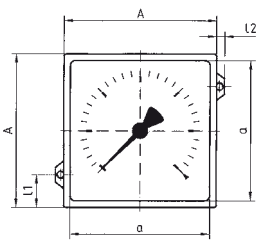
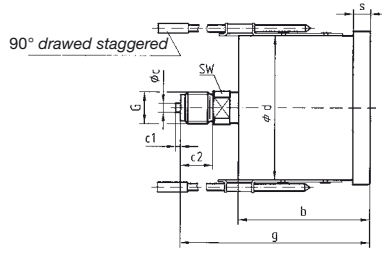
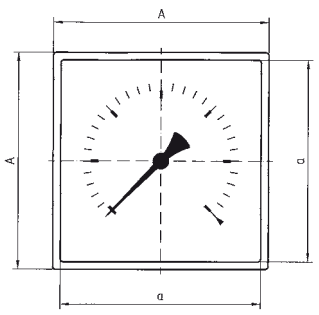
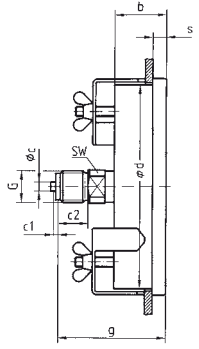
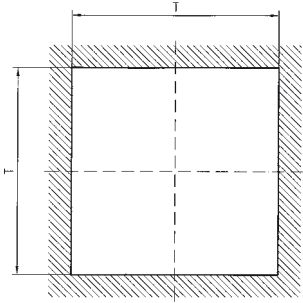
<p>Type D1 – NG 72 x 72</p> 	
<p>Type D3 / D2 – NG 96 x 96 / 144 x 144</p> 	
<p>Panel cut out</p> 	

Dimensions (mm)







Nominal size (NG)	A	a	b	∅c	c1	c2	d	G	g	l1	l2	s	SW	T						
72 x 72	72	63	63,5	5	2	13	66	G ¹ / ₄ B	86,5	17	6,5	8	14	68						
96 x 96	96	88	32	5	2	13	88	G ¹ / ₄ B	55	-	-	6,5	14	90						
144 x 144	144	134	49	6	3	20	136	G ¹ / ₂ B	81	-	-	9	22	138						

Standard capsule type pressure gauges EN 837-3

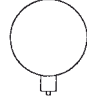
DG: M

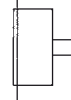
Standard version

Panel mounting version

Type	KP160,D401	KP160,D411	KP160,D431	KP160,D451		KP72,D111	KP96,D311	KP144,D211	
Version									
Housing-Ø	160	160	160	160		72 x 72	96 x 96	144 x 144	
Housing	Stainless steel 304 with bayonet type bezel						Plastic	Stainless steel	Sheet steel
Meas.elem.	Capsule element, CuBe alloy						Capsule element, CuBe alloy		
Accuracy class	1,6	1,6	1,6	1,6		1,6	1,6	1,6	
Anschluss	G ¹ / ₂ B	G ¹ / ₂ B	G ¹ / ₂ B	G ¹ / ₂ B		G ¹ / ₄ B	G ¹ / ₄ B	G ¹ / ₂ B	
			3-hole fixing, panel mounting bezel, 304, polished	Panel mounting bezel 304, polished, clamp fixing					
Range (mbar)	Part no.	Part no.	Part no.	Part no.		Part no.	Part no.	Part no.	
Price €									
-6/0	35151401	35151411	35151431	35151451		---	---	---	
-10/0	35152401	35152411	35152431	35152451		---	---	---	
-16/0	35153401	35153411	35153431	35153451		---	---	---	
Price €									
-25/0	35154401	35154411	35154431	35154451		35304111	35354311	35404211	
-40/0	35155401	35155411	35155431	35155451		35305111	35355311	35405211	
-60/0	35156401	35156411	35156431	35156451		35306111	35356311	35406211	
-100/0	35157401	35157411	35157431	35157451		35307111	35357311	35407211	
-160/0	35158401	35158411	35158431	35158451		35308111	35358311	35408211	
-250/0	35159401	35159411	35159431	35159451		35309111	35359311	35409211	
-400/0	35160401	35160411	35160431	35160451		35310111	35360311	35410211	
-600/0	35161401	35161411	35161431	35161451		35311111	35361311	35411211	
-1000/0	35162401	35162411	35162431	35162451		35312111	35362311	35412211	
Price €									
0/6	35163401	35163411	35163431	35163451		---	---	---	
0/10	35164401	35164411	35164431	35164451		---	---	---	
0/16	35165401	35165411	35165431	35165451		---	---	---	
Price €									
0/25	35166401	35166411	35166431	35166451		35316111	35366311	35416211	
0/40	35167401	35167411	35167431	35167451		35317111	35367311	35417211	
0/60	35168401	35168411	35168431	35168451		35318111	35368311	35418211	
0/100	35169401	35169411	35169431	35169451		35319111	35369311	35419211	
0/160	35170401	35170411	35170431	35170451		35320111	35370311	35420211	
0/250	35171401	35171411	35171431	35171451		35321111	35371311	35421211	
0/400	35172401	35172411	35172431	35172451		35322111	35372311	35422211	
0/600	35173401	35173411	35173431	35173451		35323111	35373311	35423211	
0/1000	35174401	35174411	35174431	35174451		35324111	35374311	35424211	